

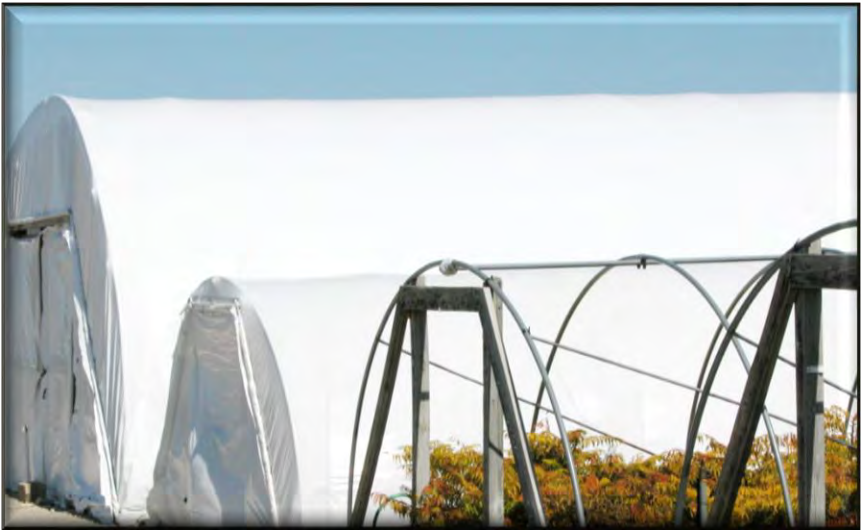

---

*VersaQuonset*  
*Pro-Line 16*  
*(16' x 80')*



**Completed Size 15'7" x 80'**

Detailed Assembly Instructions and Part List

*The following materials are included in your complete Quonset package. If you ordered a basic or special package, please see your packing list for specific building components*

---



### **MATERIALS INCLUDED IN COMPLETE PACKAGE**

- √ 21 – Structure pipes (hoops)
- √ 4 – Purlin Pipes (One end swaged)
- √ 19 – Heavy-duty cross connector brackets
- √ 2 – Cross connectors with bolts (for ends of house)
- √ 4 – Purlin pipes (non-swaged) for end bracing
- √ 24 – Cross connectors with bolts for attaching end bracing
- √ 42 – 36" Ground sleeves
- √ 12 – 2"x6"x16' Treated lumber
- √ 1 – 1"x6"x16' Treated lumber
- √ 3 – Machine bolts to connect purlin pipes
- √ 84 – Self-tapping screws to attach lumber to ground sleeve/hoop



**TOOLS & SUPPLIES NEEDED FOR CONSTRUCTION**

- √ 8 to 10 Pound sledge hammer
- √ 200 ft. of string or nylon twine
- √ 100 ft. tape measure
- √ Linesman pliers
- √ Hand or power saw
- √ 7/16" Deep well socket w/ratchet handle
- √ Power drill with Phillips bits
- √ Hack saw
- √ 100 ft. Extension cord
- √ #7 Galvanized nails
- √ Two ladders
- √ Medium screwdriver

**RECOMMENDED COVER**

- √ Poly - 28' width at variable lengths
- √ Shade Cloth – 24' width at variable lengths

**VersaQuonset Pro-Line 16  
(4 Season)  
16' X 80'**

**Fig. 1**

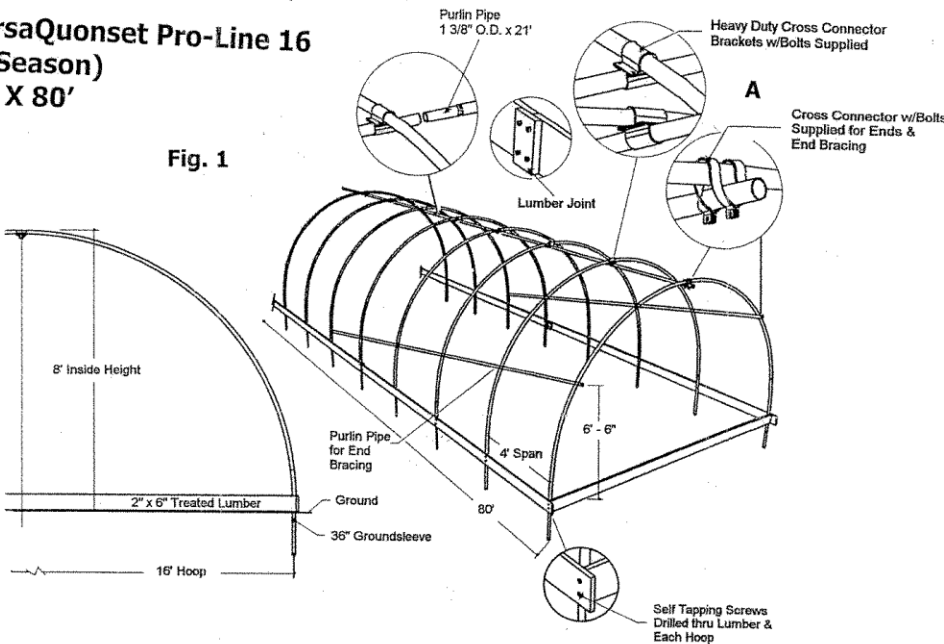

# DETAILED ASSEMBLY INSTRUCTIONS

## GROUND SLEEVES

1. Locate the exact position where the completed Quonset will stand. (Position ground sleeves at 15' 7" apart on each side.) Using a sledge hammer, drive ground sleeves into the ground on all four corners, leaving 6" above ground level. Using a tape measure, measure corner to corner to make sure it is square. **NOTE:** Depending on soil conditions, this process may be done with a board over the swaged end to protect it from deforming.

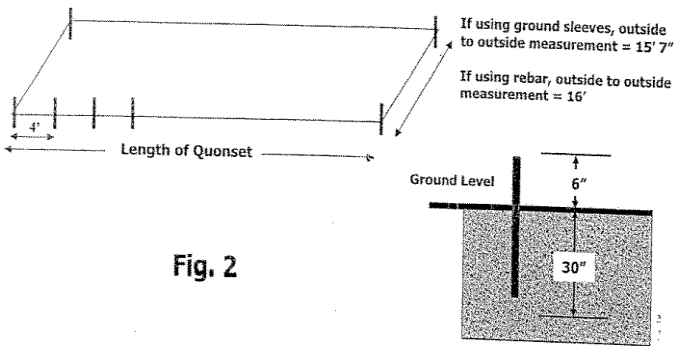

Fig. 2

2. Tie nylon twine or string to all four corners to form a rectangle.
3. On sides of Quonset, drive remaining ground sleeves every 4'. Do this on the INSIDE of string, leaving 6" of ground sleeve above ground level. Remove string.

## STRUCTURE PIPES (HOOPS) & PURLINS

1. Structure pipes (hoops) may now be installed. Starting at one end and working to opposite end; each structure pipe (hoop) fits over exposed ground sleeve.

2. Depending on length of house, all purlins should be joined together so that you have one length of pipe. DO NOT cut to Quonset length; you will cut off any excess later when instructed. Drill purlins using  $\frac{1}{4}$ " drill bit and join with  $\frac{1}{4}$ " x  $1\frac{1}{2}$ " machine bolt (see Fig. 4-A). Attach completed purlin pipe to hoops using cross connectors. Center purlin should be installed first. For ends of the house, use strap-type cross connector. For the interior connections, use the heavy duty cross connector brackets.

**Fig. 4**

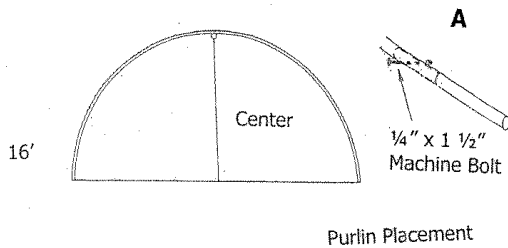

3. To install purlin, locate exact center of house. Place purlin below hoop. Tighten first/end cross connector so it does not slip out. Then, loosely attach purlin at every 4<sup>th</sup> hoop to hold in place. Loosely attach remaining connectors, starting at one end of the house and repeating down the entire length.

**Fig. 4**

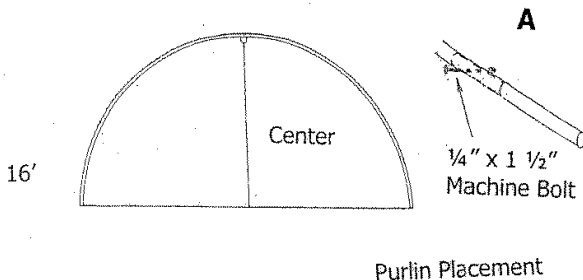

## **TIGHTENING CROSS CONNECTORS**

1. Start with first/end hoop. Working down length of house, make sure hoops are plumb and straight. To check plumb, tie string across the width of the house from the bottom of both ends of the hoop being checked to just above the 2" x 6" baseboard. Then, tie a string with plumb/weight from the TOP CENTER of the hoop where purlin is attached. If weight lines up with the string, the hoop is plumb and straight. If not, adjust the hoop on the purlin until the weight meets the string.
2. When hoops are straight, tighten cross connectors using 7/16" deep well socket on all three purlins, one hoop at a time. Work down length of the house, periodically checking the plumb of previously tightened hoops.

## **BASEBOARDS**

1. Starting from corner, lay out 2" x 6" baseboard on outside of ground sleeve, leaving 1 1/2" extra outside of Quonset dimensions. First piece cut to 14' to eliminate the problem of the junction of two boards at ground sleeve/hoop.
2. With boards standing on edge against ground sleeve/hoop, use a Philips drill bit to drill two self-tapping screws through the lumber and into the ground sleeve/hoop. (See Fig. 3)

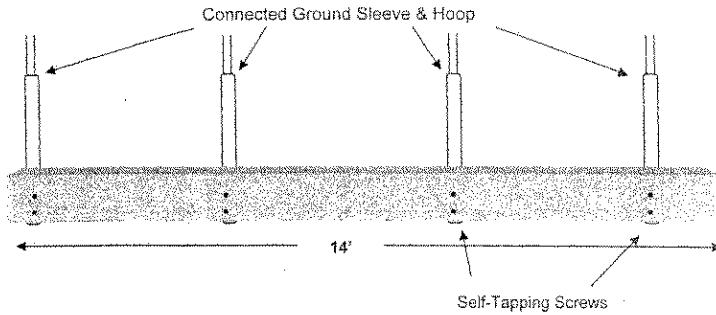

**Fig. 3**

### **ATTACHING END BRACING**

1. Use one purlin, 6 standard cross connectors and a 7/16" socket or wrench. Start from first/end hoop at about 4' above ground level and attach one end of purlin. DO NOT TIGHTEN. Use another cross connector to attach the opposite end of the purlin near the ground stake on the 6<sup>th</sup> hoop (counting the end hoop). DO NOT TIGHTEN.
2. Push on the center of the corner brace and attach it to one of the mid hoops. Then, attach the remaining three cross connectors loosely, making sure the Quonset is still plumb and square. Once all connectors are attached, push up on forward end of the purlin (at the first hoop) and down on opposite end. Do this until brace is in position (see Fig. 6). Set the end brace by tightening all cross connectors with a 7/16" deep well socket. Repeat the process for all four corners.

3. After complete assembly, use a hack saw to cut off any excess purlin there may be and tape the ends to prevent damage to the covering.

*If you require additional information or special assistance, please give us a call at 630-365-1990*



**ADDITIONAL INFORMATION**

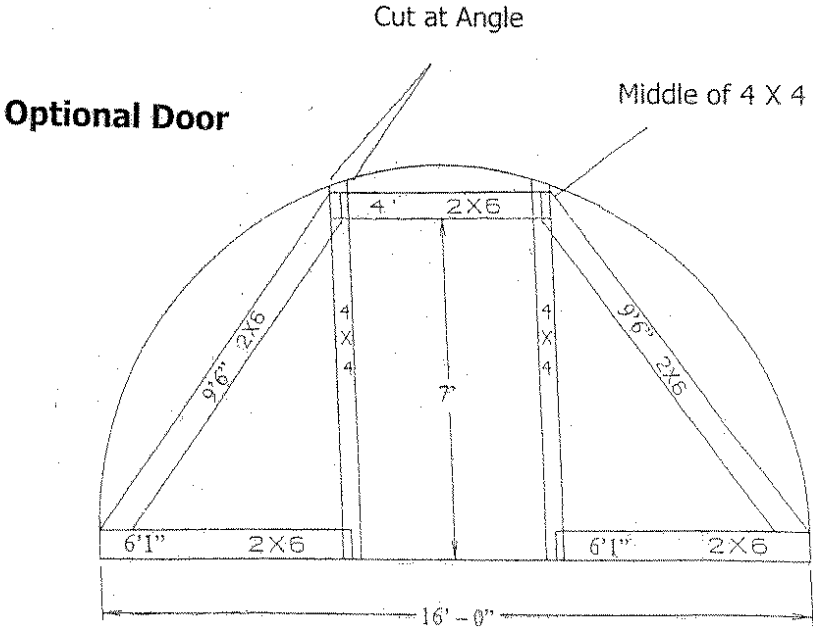

**Parts List**

- 1 - 2" x 6" X 12' 2"
- 3 - 2" X 6" x 9' 6"
- 2 - 4" X 4" X 11'



16' HOUSE		
DATE	ORDER BY	ORDER BY
7/26/94	SLC	SLC
HIGHEST TRADING		ORDER NUMBER
P.O. BOX 284		1
ST. CHARLES, IL 62624		

## WHEN USING CHANNEL LOCK TO SECURE POLY:

- The ½" Tek screw (or self-drilling screw) is used to apply the base to metal, such as a Quonset hoop. The screw is applied every 12".
- To attach the base to wood, use the stainless steel nut and bolt. They should be placed every 2'. Pre-drill a ½" hole through the base and wood.
- To apply the spring into the base, weave back and forth. Remove the same way to prevent damage to the spring so it can be used again.

